

1

2

3

4

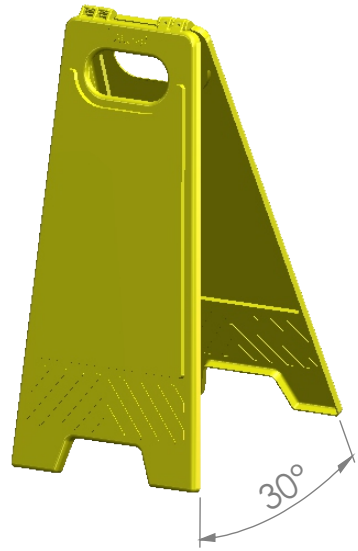
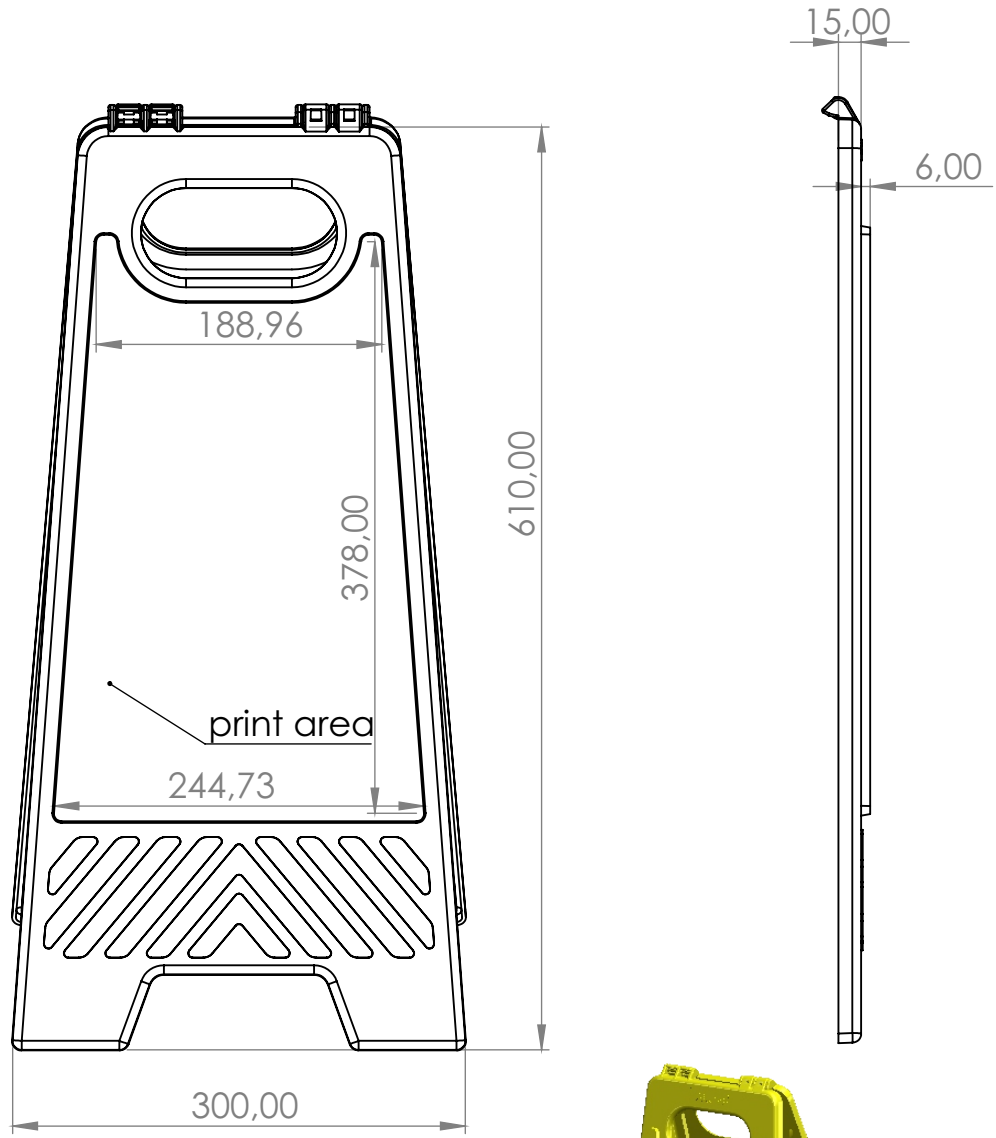

NAME -SURNAME	DATE	SIGN	MATERIAL	MASS (KG)	REVISION NO	PAGE NR
DRAWN BY	---					1/1
CONTROL	---		STOCK CODE			
APPROVAL	---					
SCALE	1:10					
PART/ASSEMBLY NAME			DRAWING DESCRIPTION	DRAWING NO	FORMAT	
			---		---	A4

A

B

C

D

E

F